



**Cambridge International Examinations**  
Cambridge International General Certificate of Secondary Education

**PHYSICS**

**0625/22**

Paper 2 Multiple Choice (Extended)

**October/November 2017**

**45 minutes**

Additional Materials: Multiple Choice Answer Sheet  
Soft clean eraser  
Soft pencil (type B or HB recommended)

\* 2 6 6 4 5 5 9 1 9 2 \*

**READ THESE INSTRUCTIONS FIRST**

Write in soft pencil.

Do not use staples, paper clips, glue or correction fluid.

Write your name, Centre number and candidate number on the Answer Sheet in the spaces provided unless this has been done for you.

**DO NOT WRITE IN ANY BARCODES.**

There are **forty** questions on this paper. Answer **all** questions. For each question there are four possible answers **A, B, C** and **D**.

Choose the **one** you consider correct and record your choice in **soft pencil** on the separate Answer Sheet.

**Read the instructions on the Answer Sheet very carefully.**

Each correct answer will score one mark. A mark will not be deducted for a wrong answer.

Any rough working should be done in this booklet.

Electronic calculators may be used.

Take the weight of 1.0 kg to be 10 N (acceleration of free fall =  $10 \text{ m/s}^2$ ).

The syllabus is approved for use in England, Wales and Northern Ireland as a Cambridge International Level 1/Level 2 Certificate.

This document consists of **18** printed pages and **2** blank pages.

- 1 A student investigates the rate of flow of oil through a funnel.

The diagrams show the experiment and the volume of oil in the measuring cylinder at the start of the experiment, and one minute later.

**0625/22/O/N/17**

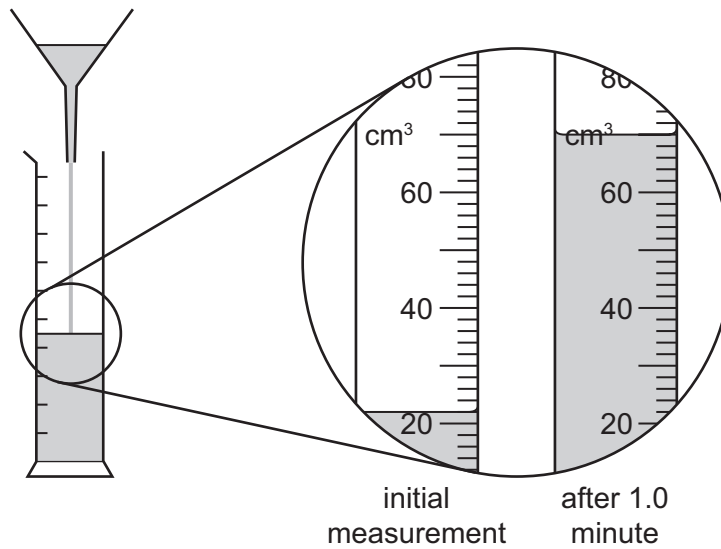

What is the rate of flow of oil through the funnel during the one minute?

- A**  $0.73 \text{ cm}^3/\text{s}$     **B**  $0.80 \text{ cm}^3/\text{s}$     **C**  $44 \text{ cm}^3/\text{s}$     **D**  $48 \text{ cm}^3/\text{s}$
- 2 Four balls with different masses are dropped simultaneously from the heights shown.

Air resistance may be ignored.

**0625/22/O/N/17**

Which ball hits the floor last?

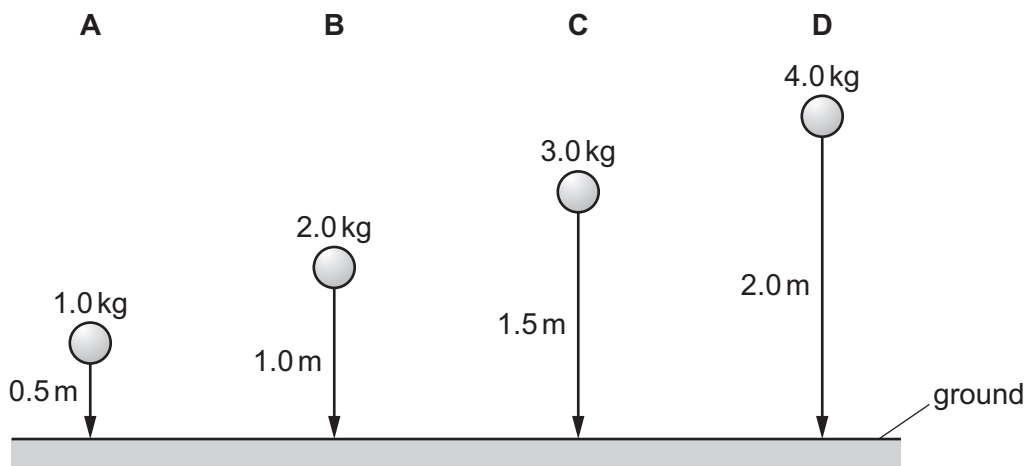

- 3 The gravitational field strength on the Earth is greater than the gravitational field strength on the Moon. The Earth has an atmosphere, but the Moon does not.

Which speed-time graph represents the motion of a light ball dropped from a great height near the surface of the Earth and near the surface of the Moon?

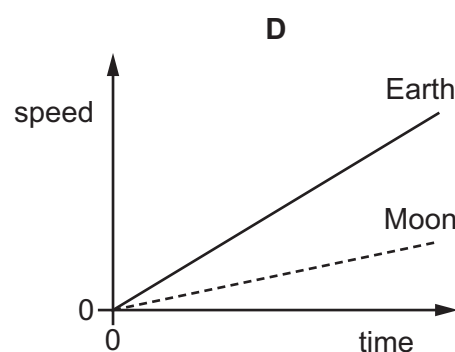
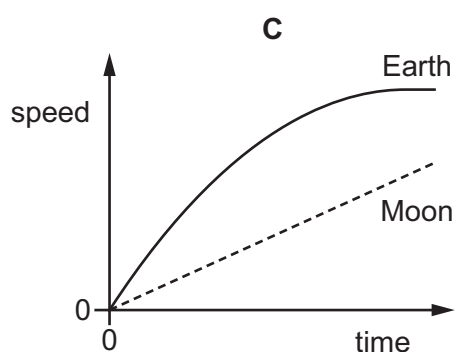
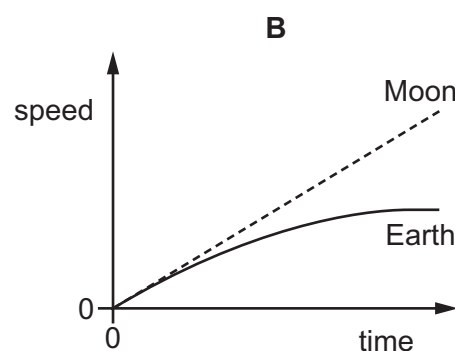
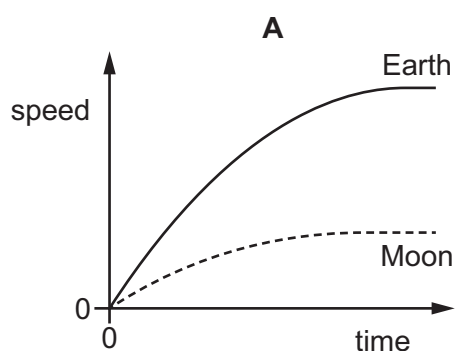

**0625/22/O/N/17**

- 4 A spring is stretched by hanging a piece of metal from it.

**0625/22/O/N/17**

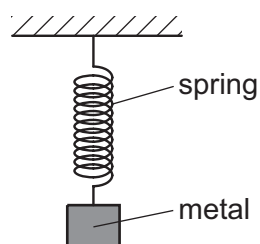

Which name is given to the force that stretches the spring?

- A** friction
- B** mass
- C** pressure
- D** weight

- 5 A body of mass  $m$  has a weight  $W$  in a location where the gravitational field strength is  $g$ .

Which statement about these quantities is correct?

**0625/22/O/N/17**

- A  $m$  and  $W$  are both forces.  
 B  $m$  and  $W$  are both vector quantities.  
 C  $m$  and  $W$  are related by the equation  $\frac{W}{m} = g$ .  
 D  $m$  and  $W$  have the same unit.

- 6 An object is pivoted at point P. A student ties a length of string to a peg on the object. He pulls the string with a force  $F$ .

**0625/22/O/N/17**

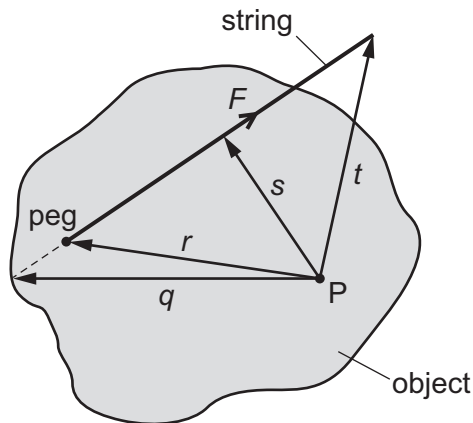

What is the moment of the force  $F$  about the point P?

- A  $F \times q$       B  $F \times r$       C  $F \times s$       D  $F \times t$

- 7 Each diagram shows a metal plate with four parallel forces acting on it. These are the only forces acting on the plates.

**0625/22/O/N/17**

In which diagram is the plate in equilibrium?

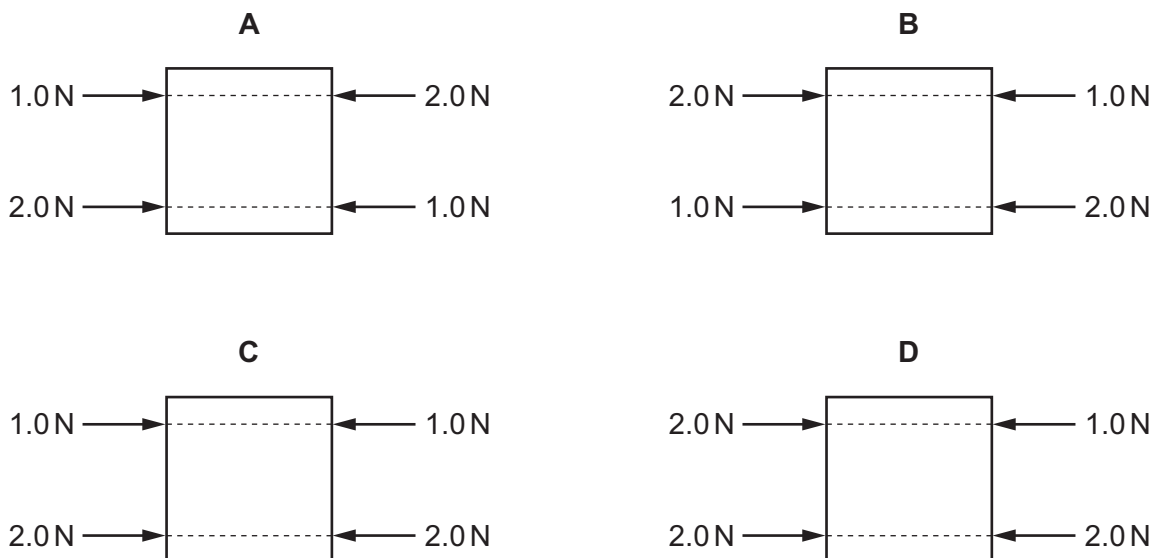

- 8 The diagram shows an incomplete scale drawing to find the resultant of two 10 N forces acting at a point in the directions shown.

0625/22/O/N/17

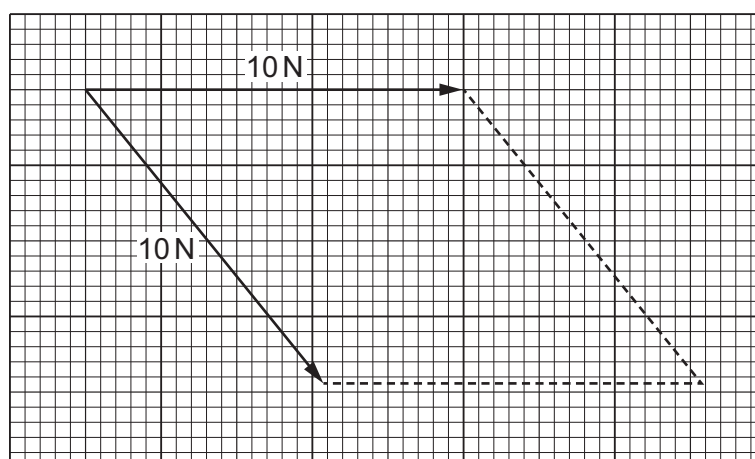

What is the magnitude of the resultant force?

- A 7.5 N      B 8.6 N      C 18 N      D 20 N
- 9 A ball has a mass of 0.30 kg. It moves horizontally with a speed of 3.0 m/s in the direction shown.

The ball hits a wall.

0625/22/O/N/17

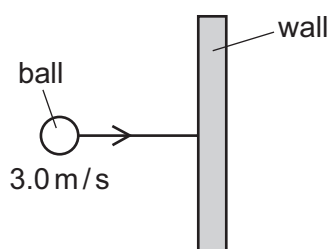

before hitting the wall

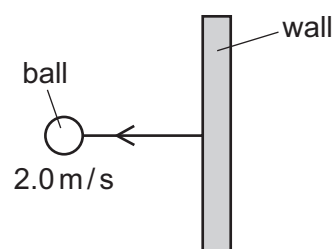

after hitting the wall

The ball rebounds from the wall with a horizontal speed of 2.0 m/s.

What is the change in momentum of the ball?

- A 0.30 kg m/s      B 1.0 kg m/s      C 1.5 kg m/s      D 5.0 kg m/s
- 10 An object has a mass of 500 kg.

0625/22/O/N/17

It moves with a speed of 30 m/s.

What is its kinetic energy?

- A 7.5 kJ      B 15 kJ      C 225 kJ      D 450 kJ

11 Different processes have different efficiencies.

0625/22/O/N/17

Which row shows the most efficient process?

	energy input/J	useful energy output/J
<b>A</b>	10	3
<b>B</b>	40	10
<b>C</b>	100	25
<b>D</b>	2000	250

12 A student runs up a flight of stairs.

0625/22/O/N/17

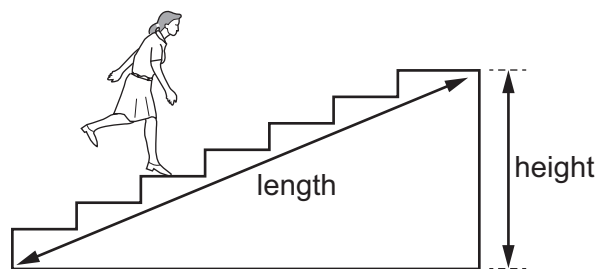

Which information is **not** needed to calculate the rate at which the student is doing work against gravity?

- A** the height of the flight of stairs
- B** the length of the flight of stairs
- C** the time taken to run up the stairs
- D** the weight of the student

13 The diagram shows a simple mercury barometer.

0625/22/O/N/17

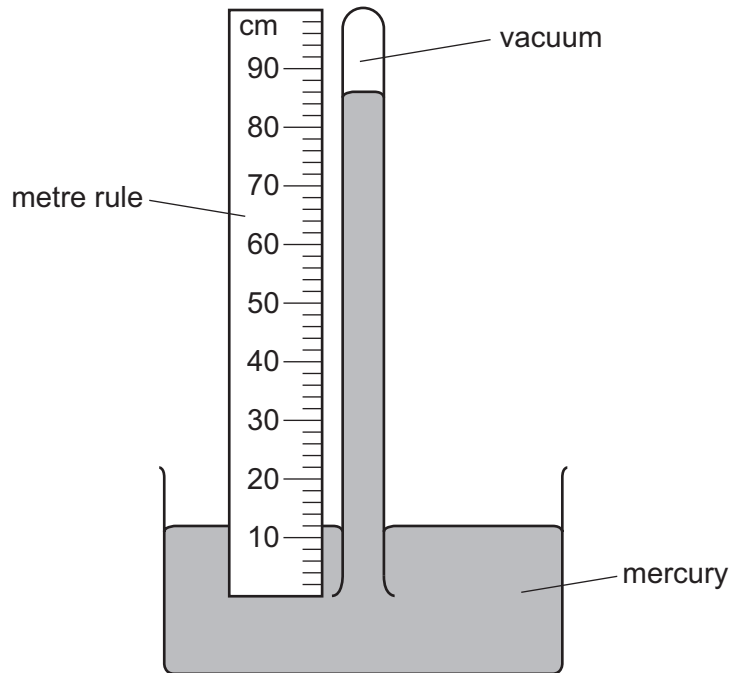

Which length is used to find the value of atmospheric pressure?

- A 12 cm      B 74 cm      C 86 cm      D 100 cm

14 A pollen grain in a beaker of still water is viewed through a microscope.

Which diagram shows the most likely movement of the pollen grain?

0625/22/O/N/17

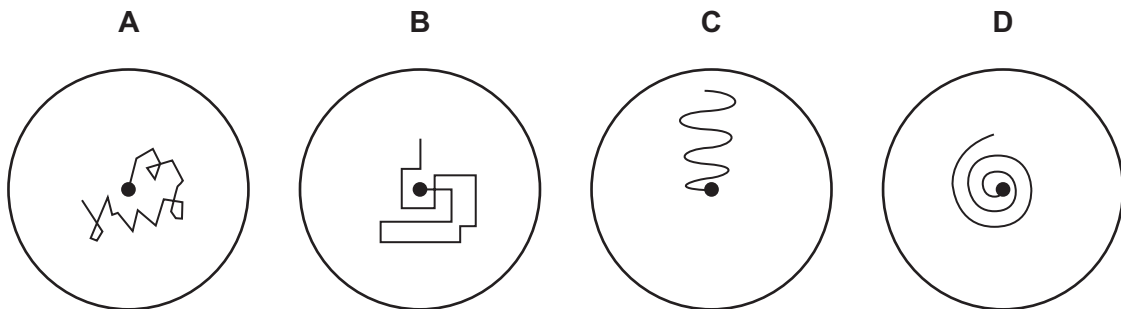

- 15 The diagram shows an air-filled rubber toy. A child sits on the toy and its volume decreases.

The temperature of the air in the toy does not change.

0625/22/O/N/17

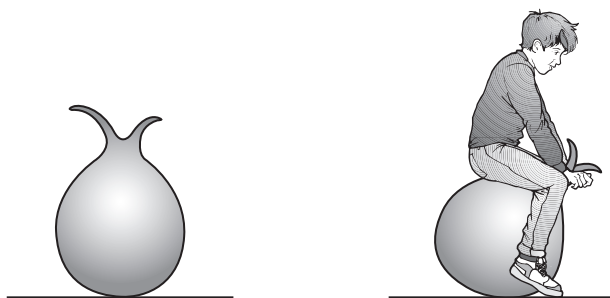

How does the air pressure in the toy change and why?

	pressure	reason
<b>A</b>	decreases	air molecules move more slowly
<b>B</b>	decreases	air molecules strike the rubber less frequently
<b>C</b>	increases	air molecules move more quickly
<b>D</b>	increases	air molecules strike the rubber more frequently

- 16 The diagram shows a glass flask, sealed with a small volume of mercury in a glass tube. When the flask is gently warmed the mercury rises up the tube.

0625/22/O/N/17

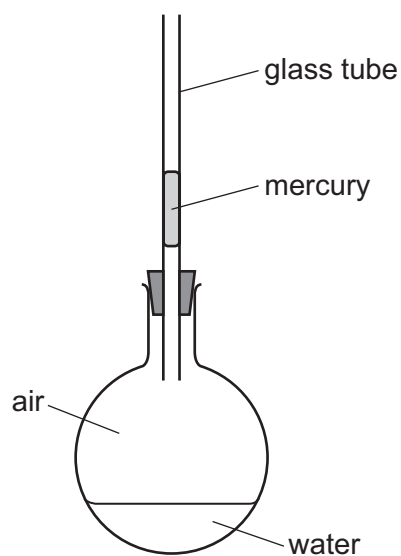

What is the main cause of the movement of the mercury?

- A** expansion of air in the flask
- B** expansion of the glass flask
- C** expansion of the glass tube
- D** expansion of the mercury



17 Which row identifies the fixed points on the Celsius scale?

**0625/22/O/N/17**

	lower fixed point	upper fixed point
<b>A</b>	boiling point of mercury	melting point of pure ice
<b>B</b>	boiling point of pure water	melting point of pure ice
<b>C</b>	melting point of mercury	boiling point of pure water
<b>D</b>	melting point of pure ice	boiling point of pure water

18 Aluminium has a specific heat capacity of  $900 \text{ J / (kg } ^\circ\text{C)}$ .

**0625/22/O/N/17**

The internal energy of a  $2.0 \text{ kg}$  block of aluminium increases by  $13\,500 \text{ J}$ .

By how much does the temperature of the block increase?

- A**  $0.067 \text{ } ^\circ\text{C}$       **B**  $0.13 \text{ } ^\circ\text{C}$       **C**  $7.5 \text{ } ^\circ\text{C}$       **D**  $15 \text{ } ^\circ\text{C}$

19 Why does a balloon filled with hot air rise?

**0625/22/O/N/17**

- A** Cold air is less dense than hot air.  
**B** Cold air is more dense than hot air.  
**C** Heat rises.  
**D** The density of the balloon is greater than the density of the surrounding gas.

20 The diagram represents plane wavefronts of a water wave about to strike a solid barrier.

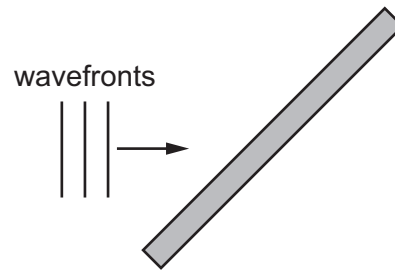

0625/22/O/N/17

Which diagram shows the position of the wavefronts after reflection at the barrier?

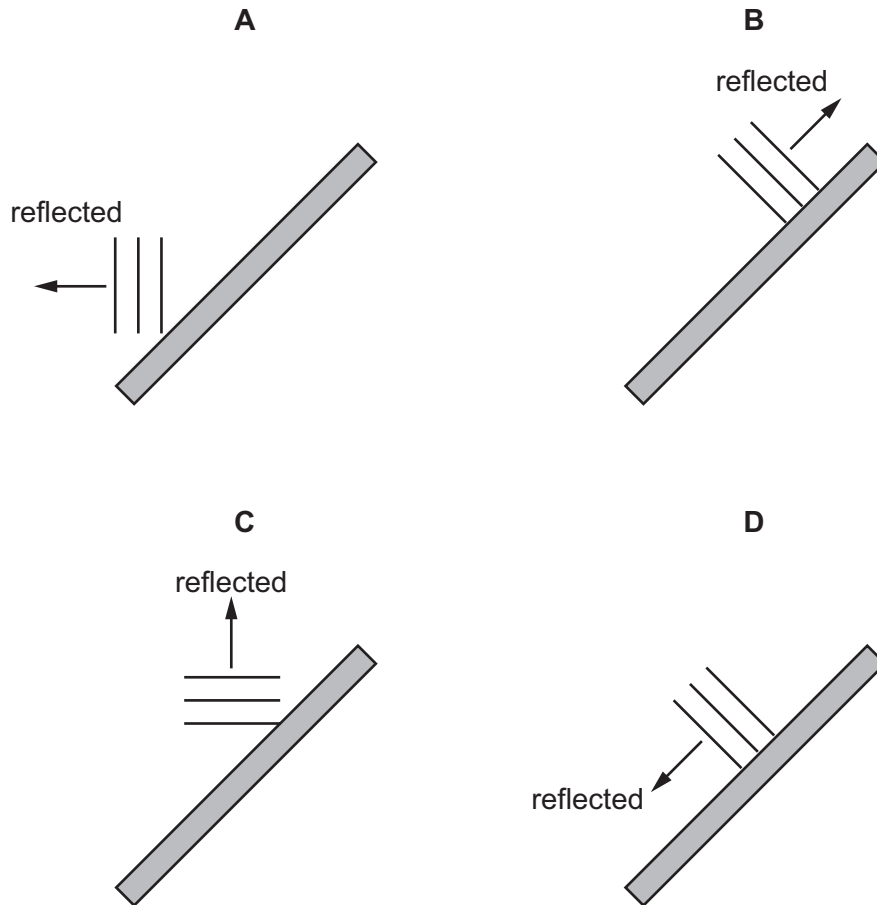

- 21 The diagram shows an object O in front of a thin converging lens of focal length  $f$ .

At which point will the lens form a sharp image of the object?

**0625/22/O/N/17**

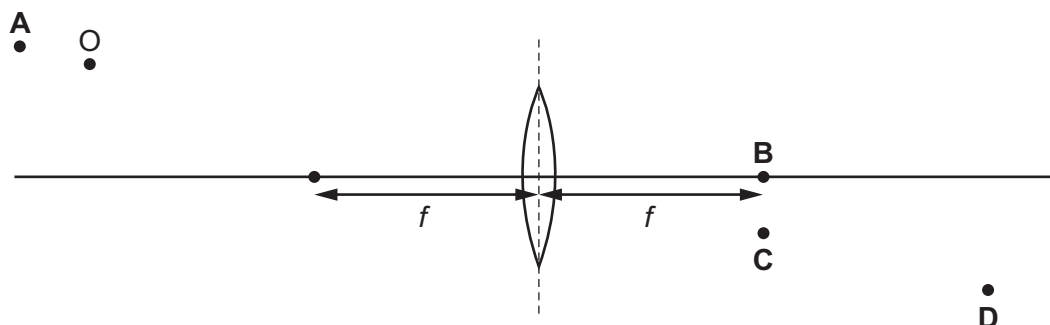

- 22 The diagram shows a ray of light incident on the surface of a rectangular glass block at  $90^\circ$  to the surface.

**0625/22/O/N/17**

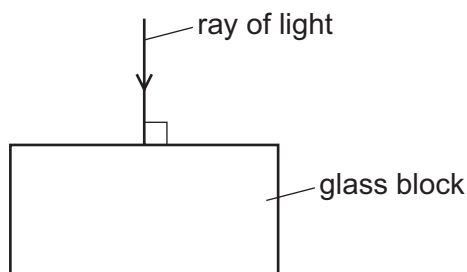

Which quantities remain unchanged as the light enters the glass block?

**0625/22/O/N/17**

- A** direction and frequency  
**B** direction and speed  
**C** frequency and speed  
**D** speed and wavelength
- 23 Which piece of equipment is designed to produce a type of electromagnetic wave?
- A** electric fire  
**B** electric generator  
**C** electric motor  
**D** electromagnet
- 24 The Moon is 380 000 km from the Earth. A laser light beam is directed from the Earth to the Moon. The beam is reflected back to the Earth.

**0625/22/O/N/17**

How long does it take for the light to travel to the Moon and back to the Earth?

- A** 1.27 ms      **B** 2.53 ms      **C** 1.27 s      **D** 2.53 s

25 Different waves travel through air.

**0625/22/O/N/17**

Which waves have the greatest difference in speed?

- A ultrasound waves and sound waves
- B ultrasound waves and ultraviolet waves
- C ultraviolet waves and light waves
- D ultraviolet waves and radio waves

26 The speed of sound is different in different states of matter.

**0625/22/O/N/17**

The speed of sound in water is 1500 m/s.

Which row correctly compares the speed of sound in ice and the speed of sound in steam with the speed of sound in water?

	<u>speed of sound in ice</u> m/s	<u>speed of sound in steam</u> m/s
<b>A</b>	less than 1500	less than 1500
<b>B</b>	less than 1500	more than 1500
<b>C</b>	more than 1500	less than 1500
<b>D</b>	more than 1500	more than 1500

27 A student finds that it takes sound 0.33 seconds to travel 100 metres.

From this information, what is the speed of sound?

**0625/22/O/N/17**

- A 30 m/s      B 60 m/s      C 300 m/s      D 600 m/s

- 28 A train of steel nails and a train of iron nails hang from a strong magnet.

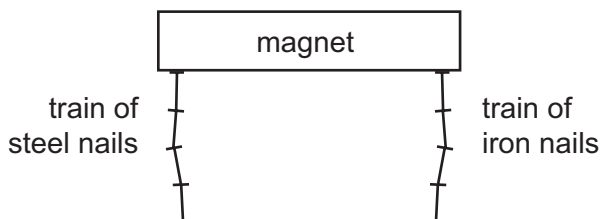

0625/22/O/N/17

The trains are then carefully removed from the magnet.

What happens to the trains?

- A** Both trains fall apart.  
**B** Both trains stay together.  
**C** Only the train of iron nails falls apart.  
**D** Only the train of steel nails falls apart.
- 29 An old and expensive steel watch becomes magnetised.

0625/22/O/N/17

The owner wants to use the watch again. He must demagnetise the watch.

What is the **best** method to do this?

- A** Insert the watch in a solenoid that carries alternating current and then slowly remove it.  
**B** Insert the watch in a solenoid that carries direct current and then slowly remove it.  
**C** Pass alternating current through the watch.  
**D** Pass direct current through the watch.
- 30 Which diagram represents the electric field due to a negatively-charged conducting sphere?

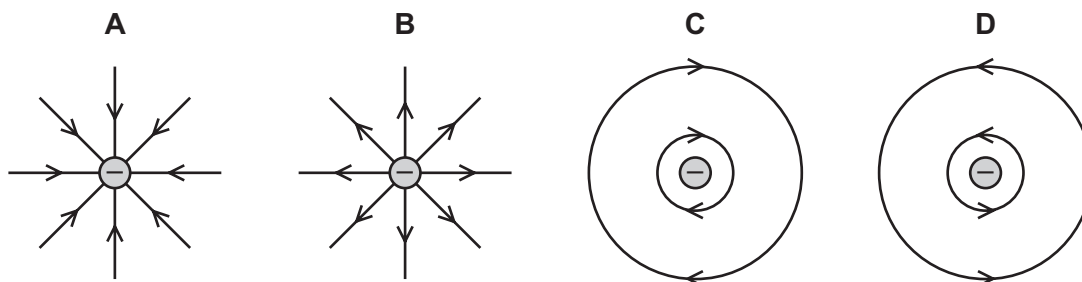

0625/22/O/N/17

- 31 The diagram shows a circuit with a gap between points P and Q.

0625/22/O/N/17

Four pieces of metal wire of the same material are connected, in turn, between points P and Q in the circuit.

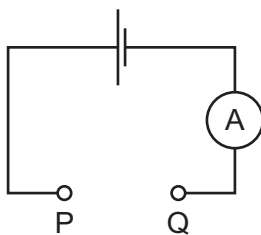

The table gives the diameters and lengths of the wires.

In which wire is the current the largest?

	diameter / mm	length / m
<b>A</b>	0.10	1.0
<b>B</b>	0.10	2.0
<b>C</b>	0.20	1.0
<b>D</b>	0.20	2.0

- 32 The graph shows the way in which one physical quantity  $y$  varies with another physical quantity  $x$ .

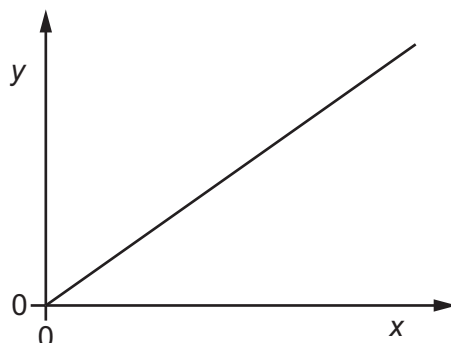

0625/22/O/N/17

Which row gives suitable quantities for  $y$  and  $x$ ?

	$y$	$x$
<b>A</b>	the number of atoms of a radioactive isotope present	the time taken
<b>B</b>	the potential difference across a metallic conductor	the current in the metallic conductor
<b>C</b>	the resistance of a length of wire	the diameter of the wire
<b>D</b>	the volume of a 1.0 kg object	the density of the material from which the object is made

- 33 The potential difference across a car headlamp is 12 V. The current in the lamp is 2.5 A.

**0625/22/O/N/17**

How much energy is transferred by the lamp in 1.0 hour?

- A 1800 J      B 1800 W      C 108 000 J      D 108 000 W

- 34 The diagram shows a circuit with a fixed resistor connected in series with a thermistor and an ammeter.

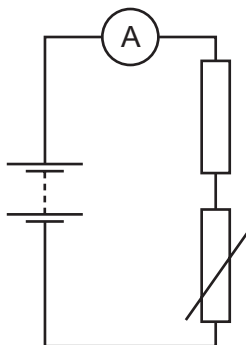

Which row shows how temperature change affects the resistance of the thermistor and the current in the circuit?

**0625/22/O/N/17**

	temperature	resistance of thermistor	current in circuit
<b>A</b>	decreases	decreases	increases
<b>B</b>	decreases	increases	decreases
<b>C</b>	increases	decreases	decreases
<b>D</b>	increases	increases	increases

- 35 An incomplete truth table for a NAND gate is shown.

0625/22/O/N/17

input P	input Q	output
0	0	W
0	1	X
1	0	Y
1	1	Z

What are the values of W, X, Y and Z?

	W	X	Y	Z
<b>A</b>	0	0	0	1
<b>B</b>	0	1	1	1
<b>C</b>	1	0	0	0
<b>D</b>	1	1	1	0

- 36 The diagram shows a wire hanging freely between the poles of a magnet. There is a current in the wire in the direction shown.

0625/22/O/N/17

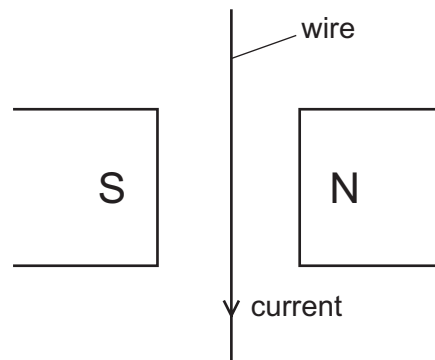

The magnet and current cause a force to act on the wire.

In which direction does this force act?

- A** into the page (away from you)
- B** out of the page (toward you)
- C** to the left
- D** to the right



- 37 A 100% efficient transformer has 6000 turns on its primary coil and 600 turns on its secondary coil. The output voltage of the transformer is 12 V.

A resistor is connected across the secondary coil and dissipates 24 W of power.

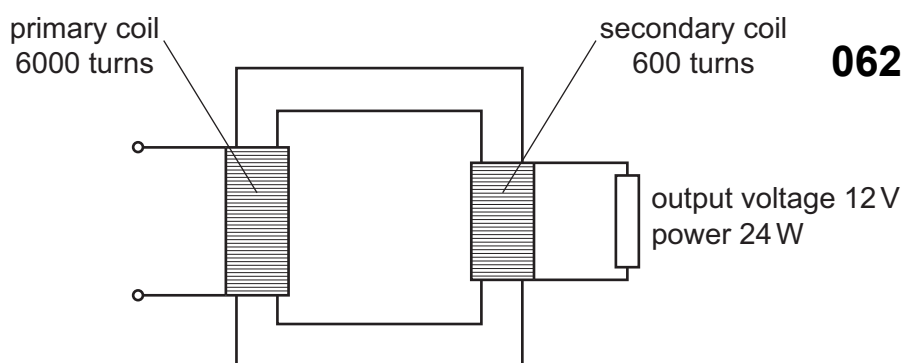

What is the current in the primary coil of the transformer?

- A 0.050 A      B 0.20 A      C 5.0 A      D 20 A
- 38 In the diagram, the circle represents an atom (not to scale) with the nucleus at its centre.

A particle is emitted by a radioactive source and approaches the nucleus of the atom. The curved arrow shows the path of the particle.

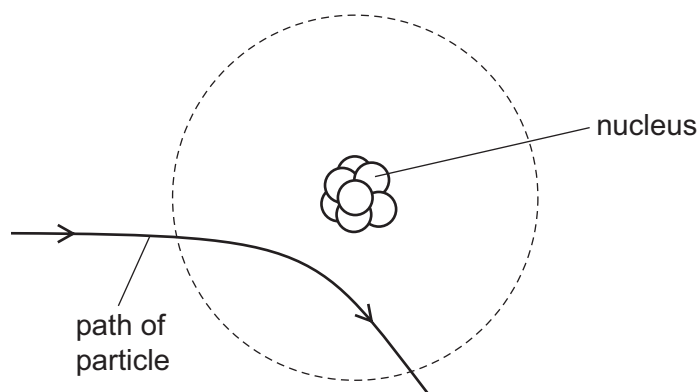

What is the nature and charge of the particle?

	nature of particle	charge of particle
A	$\alpha$ -particle	negative
B	$\alpha$ -particle	positive
C	$\beta$ -particle	negative
D	$\beta$ -particle	positive

39 Which row describes the behaviour of  $\gamma$ -rays in an electric field and in a magnetic field?

	electric field	magnetic field
<b>A</b>	deflected	deflected
<b>B</b>	deflected	undeflected
<b>C</b>	undeflected	deflected
<b>D</b>	undeflected	undeflected

**0625/22/O/N/17**

40 A radioactive source has a half-life of 0.5 hours.

A detector near the source shows a reading of 6000 counts per second.

Background radiation can be ignored.

What is the reading on the detector 1.5 hours later?

- A** 750 counts per second
- B** 1500 counts per second
- C** 2000 counts per second
- D** 3000 counts per second

**0625/22/O/N/17**



**BLANK PAGE**

---

Permission to reproduce items where third-party owned material protected by copyright is included has been sought and cleared where possible. Every reasonable effort has been made by the publisher (UCLES) to trace copyright holders, but if any items requiring clearance have unwittingly been included, the publisher will be pleased to make amends at the earliest possible opportunity.

To avoid the issue of disclosure of answer-related information to candidates, all copyright acknowledgements are reproduced online in the Cambridge International Examinations Copyright Acknowledgements Booklet. This is produced for each series of examinations and is freely available to download at [www.cie.org.uk](http://www.cie.org.uk) after the live examination series.

Cambridge International Examinations is part of the Cambridge Assessment Group. Cambridge Assessment is the brand name of University of Cambridge Local Examinations Syndicate (UCLES), which is itself a department of the University of Cambridge.